

ENVIRONMENTAL PRODUCT DECLARATION

KONE N MonoSpace®, KONE N MonoSpace® DX

Registration number: RTS_65_20
Declaration number: RTS_65_20
Eco Platform
reference number: 00001216
Published: 2020-04-29
Valid until: 2025-04-21
Revision number: 1.0

KONE IN BRIEF

At KONE, our mission is to improve the flow of urban life. As a global leader in the elevator and escalator industry, KONE provides elevators, escalators and automatic building doors, as well as solutions for modernization and maintenance to add value to buildings throughout their life cycle. KONE's equipment moves over 1 billion users each day. Through more effective People Flow®, we make people's journeys safe, convenient and reliable in taller, smarter buildings.

We serve more than 450,000 customers across the globe, and have more than one million elevators and escalators in our service base. Key customer groups include builders, building owners, facility managers and developers. The majority of these are maintenance customers. Architects, authorities and consultants are also key influencers in the decision-making process regarding elevators and escalators.

DRIVING INNOVATION AND IMPROVING RESOURCE EFFICIENCY

At KONE, innovation means putting the customer and the equipment user at the center. Innovations can have an important role in addressing climate change. Increasing resource efficiency is among our top priorities with regards to both our solutions and our operations. Our solution design contributes to the circular economy with a long lifetime and modularity as key features of our products, supported by our maintenance and modernization services.

LEADER IN SUSTAINABILITY

At KONE, sustainability is embedded in our organizational culture. It is how we treat each other and our stakeholders, how we take the environment into account in all of our actions, and how we foster economic performance now and in the future. Our vision is to deliver the best People Flow experience. Sustainability is a source of innovation and a competitive advantage for us. KONE is committed to conducting our business in a responsible and sustainable way and we expect the same commitment from our partners.



GENERAL INFORMATION, DECLARATION SCOPE AND VERIFICATION

Owner of the declaration, manufacturer	Kone Corporation Keilasatama 3 02150 Espoo, Finland Hanna Uusitalo hanna.uusitalo@kone.com
Product name and number	KONE N MonoSpace®, KONE N MonoSpace® DX
Place of production	The components are manufactured either in KONE's manufacturing units or by our suppliers with production location in China.
Additional information	www.kone.com
Product Category Rules and the scope of the declaration	This Environmental Product Declaration (EPD) has been prepared in accordance with EN 15804:2012+A1:2013 and ISO 14025 standards together with the RTS PCR (English version, 14.6.2018). Product specific category rules have not been applied in this EPD. The LCA study was completed in 2020 and is based on KONE and its suppliers' production data from 2018, collected in 2019. The used background data is not older than 10 years as per the requirement stated in EN 15804. EPDs of construction materials may not be comparable if they do not comply with EN 15804 and are seen in a building context.
Name of the used certified EPD tool	KONE-EPD One-Click LCA
Author of the life cycle assessment and declaration	Nikunj Pokhrel and Jackson Zhang KONE Corporation nikunj.pokhrel@kone.com, jackson.zhang@kone.com
Verification	This EPD has been verified according to the requirements of ISO 14025:2010, EN 15804:2012+A1:2013 and RTS PCR by a third party. The verification has been carried out by Bionova Ltd Tytti Bruce Hyrkäs Hämeentie 31 00500 Helsinki Finland www.bionova.fi.
Declaration issue date and validity	2020-04-29 2020-04-21 – 2025-04-21

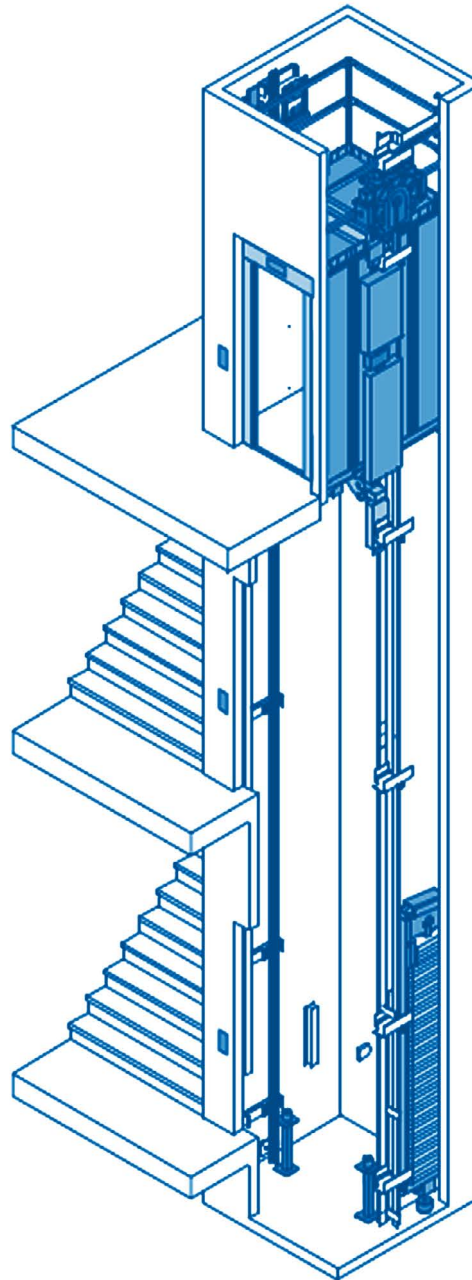

RAKENNUSTIETO

29.4.2020
Building Information Foundation
RTS
Malminkatu 16 A
00100 Helsinki
epd.rts.fi

Laura Sariola
Committee secretary

Markku Hedman RTS
General director



EUROPEAN STANDARD EN 15804: 2014 A1 SERVES AS THE CORE PCR

Independent verification of the declaration and data,
according to ISO14025:2010

Internal

External

Third party verifier:
Tytti Bruce, Bionova Ltd.



PRODUCT INFORMATION

PRODUCT DESCRIPTION

The KONE N MonoSpace® is a flexible high-quality elevator for low- to mid-rise buildings with excellent eco-efficiency, superb ride comfort and a range of design options. This machine-room-less elevator is energy- and space-efficient and comes with the eco-efficient KONE EcoDisc® hoisting machine, efficient lighting and advanced stand-by solutions.

PRODUCT STANDARDS

EN 81-20 Safety rules for the construction and installation of lifts Part 20: Passenger and goods passenger lifts.

In addition to the above standard, N MonoSpace® also complies with other relevant standards of EN 81 series related to the safety rules for construction and installation of lifts.

PHYSICAL PROPERTIES

The total mass of the elevator is 4,961 kg and it is designed to fit up to 13 people. It has one entrance way to the elevator car. The reference N MonoSpace® car has an area of 2.2 m², height of 2.2 m and it is mainly composed of ferrous metal. A counterweight made of reinforced concrete is used to balance the load of the car. For more details visit www.kone.com and contact your local KONE sales organization.



TECHNICAL SPECIFICATIONS

Table 1. Technical specifications of KONE N MonoSpace® elevator

Index	Representative values
Type of installation	New generic elevator
Commercial name	KONE N MonoSpace®, KONE N MonoSpace® DX
Main purpose	Transport of passengers
Type of elevator	Electric
Type of drive system	Gearless traction
Rated load	1000 kg
Rated speed	1.0 m/s
Number of stops	5 floors
Traveled height	12 m
Internal dimension of the elevator car	2.2 m x 1.6 m x 1.4 m
Number of operating days per year	365
Applied usage category (UC) according to ISO 25745-2	3
Designed reference service life	25 years*
Installation location	China
Recommended application	Residential buildings, offices, hospitals, hotels, airports and shopping centers

* The designed reference service life is aligned with the typical service life data published by elevator manufacturers. For elevators, it may take up to 20–30 years before major retrofitting is necessary. (Sachs, Harvey M. (2005): Opportunities for Elevator Energy Efficiency Improvements, ACEEE). The reference conditions for achieving the declared reference service life is primarily influenced by maintenance frequency/replacement of components and usage conditions such as frequency of use of the lift. Typical change interval of ropes is 8 years for the studied lift while a timely maintenance check of other components is also encouraged. The change frequency of the component is same for the elevators whose maximum usage is up to 200,000 starts / year.

RAW MATERIALS OF THE PRODUCT

The table below shows the material summary of the elevator studied, as delivered and installed in a building and handed over to a customer.

Table 2. Raw-materials used in one unit of KONE N MonoSpace® elevator

Product structure / composition/ raw-material	Amount %
Ferrous-metals (zinc coated steel, stainless steel, cold rolled steel, cast iron)	70.43
Inorganic materials (Concrete)	24.19
Electronics and electrical equipment (cables, control units, PWB assembly, LED, battery)	2.06
Plastics & rubbers (thermoplastics, synthetic rubbers)	1.52
Non-ferrous metals (aluminium, copper)	0.85
Others (glues, lubricants, paint)	0.60
Organic materials (plywood, hemp fiber)	0.35

Table 3. Raw-materials used in packaging of one unit of KONE N MonoSpace® elevator

Material	Amount %
Plywood	77.9
Plastic (LDPE, EPE, EVA)	10.8
Cardboard	6.0
Metals	5.1
Others	0.2

SUBSTANCES UNDER EUROPEAN CHEMICALS AGENCY'S REACH, SVHC RESTRICTIONS

Following the requirements of EN 15804 and RTS PCR for the declaration of substances on the candidate list of substances of very high concern (SVHC), we can conclude that to the best of our knowledge and based on the evidence provided by our suppliers the studied reference product does not contain substances on the SVHC list above 0.1% by weight of the product.

Material summary of a KONE N MonoSpace® unit

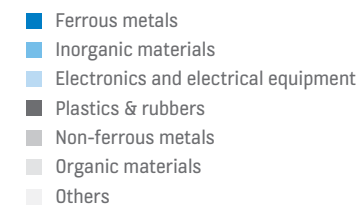
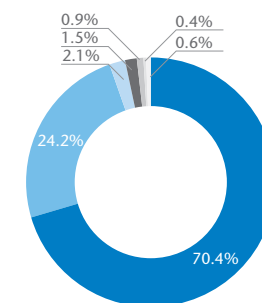

Material summary of packaging of a KONE N MonoSpace® unit

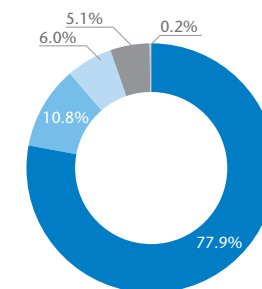



FUNCTIONAL / DECLARED UNIT

Since the purpose of the elevator is to transport people and goods over multi-floor buildings, the functional unit (FU) for the study is defined as the transportation of the load over distance, expressed in tonne [t] over a kilometer [km], i.e. tonne-kilometer [tkm]. The FU for N MonoSpace® in its lifetime was calculated to be 724 tkm.

SYSTEM BOUNDARY

This EPD covers the full life cycle stages from cradle to grave; A1 (Raw material supply), A2 (Transportation to manufacturing site), A3 (Manufacturing), A4 (Transportation of the product to the building site), A5 (Installation). For the use stage, only B4 (Replacement) and B6 (Energy consumption in the use stage) are taken into account as other modules within this stage are irrelevant for the product. At the end of life stage, C1 -C4 (Deconstruction-Disposal) is modeled and taken into account. In addition, module D showing benefits and loads beyond the system boundary has been included.

CUT-OFF CRITERIA

This study follows the cut-off criteria stated in RTS PCR and EN 15804 standard and does not exclude any modules or processes which are stated mandatory in the EN 15804 standard and in the RTS PCR. For A1-A3, amount of material consumption, packaging, transportation and manufacturing data from the factory was received for each of the 10 modules. However, the material classification was not possible for 11.83 kg of the material used in the product. The missing material data represents only 0.24% of the total weight of the lift and their production is left out from the LCA analysis. Other materials with negligible quantities (kg) in the product that are excluded from the analysis are knots, bolts, screws, and labels and stickers. A4

transportation has been calculated but the return trip is not considered. Potential energy usage in distribution center per elevator delivered is negligible and are not included in the analysis. Similarly, the impacts of the auxiliary materials used for the installation and replacement in A5 and B4 (example; gloves, adhesive tapes and cleaning agents) is excluded from the analysis since both their usage quantity and impacts are considered negligible.

PRODUCTION PROCESS

The main raw material of the elevator is ferrous metal, majority of which can be recycled after the end of life of the product. The different components of the product, also known as elevator modules are manufactured at specific sites in different parts of the world. The manufactured modules are packaged and first shipped to the KONE distribution center from where all the modules are then sent together to the customer site for installation.

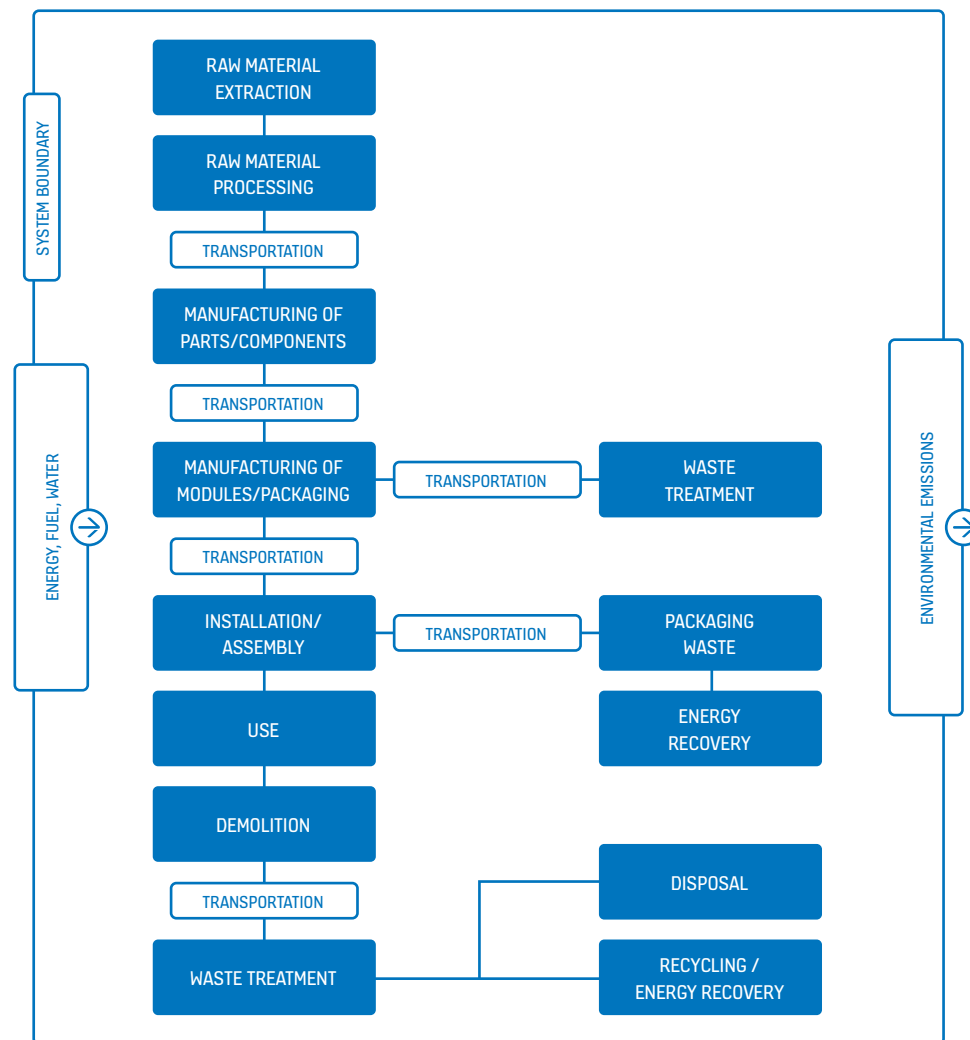

SCOPE OF THE LIFE CYCLE ASSESSMENT

All the modules covered in the EPD are marked with X.
 Mandatory modules are marked with blue in the table below.
 This declaration covers “cradle to grave”.
 For non-relevant fields, MNR is marked in the table (module not related).

Product stage			Assembly stage		Use stage						End of life stage				Beyond the system boundaries			
A1	A2	A3	A4	A5	B1	B2	B3	B4	B5	B6	B7	C1	C2	C3	C4	D	D	D
x	x	x	x	x	MNR	MNR	MNR	x	MNR	x	MNR	x	x	x	x	x	x	x
Raw materials	Transport	Manufacturing	Transport	Assembly	Use	Maintenance	Repair	Replacement	Refurbishment	Operational energy use	Operational water use	De-contruction demolition	Transport	Waste processing	Disposal	Reuse	Recovery	Recycling

- Mandatory modules
- Mandatory as per the RTS PCR section 6.2.1 rules and terms
- Optional modules based on scenarios



ENVIRONMENTAL IMPACTS

The results of a life cycle assessment are relative. They do not predict impact on category endpoints, exceeding of limit values, safety margins, or risks. The CML impact assessment method and its related characterization factors were employed at the midpoint level in this study, i.e. without normalization and weighing. Impact categories included were abiotic depletion of fossil resources and elements, acidification potential, ozone depletion potential, global warming potential, eutrophication potential and photochemical ozone creation potential. The global warming potential of modules A1-A3 is mainly caused by material manufacturing, with steel production activity having the highest share of 60% of the impacts. The elevator of this study is in use in Shanghai, China. The annual energy consumption of 1,850 kWh* was calculated with ISO 25745-2 methodology. The impacts for B6 were calculated using the energy production fuel mixes for China which is predominantly fossil based. This directly results in the large GWP impacts for the operational usage stage. The results of the life cycle impact assessment are divided by life cycle stage per entire life cycle and per tkm. Detailed results can be seen from the tables below.

Figure 1. Results for GWP and ADP of fossil resources of KONE N MonoSpace® elevator

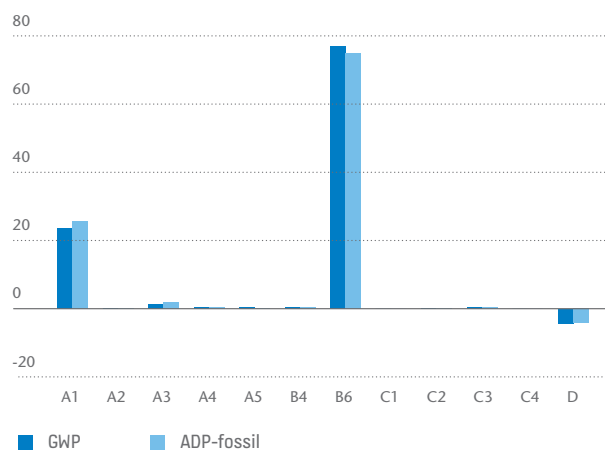

* The results of the energy calculation are based on the typical energy consumption of a KONE N MonoSpace® elevator. The results are KONE's best estimates of the annual energy consumption but the real-life values may vary depending on the actual installation.

Table 4. Potential environmental impacts per entire life cycle of KONE N MonoSpace® elevator

	GWP [kg CO ₂]	ODP [kg CFC-11e]	POCP [kg C ₂ H ₄]	AP [kg SO ₂]	EP [kg PO ₄]	ADP-elements [kg Sbe]	ADP-fossil [MJ]
A1 Materials Manufacturing	1.59E+04	1.10E-03	6.99E+00	1.04E+02	3.90E+01	2.18E+00	2.22E+05
A2 Transport to the manufacturer	8.56E+01	1.60E-05	1.30E-02	2.20E-01	2.80E-02	8.40E-04	1.33E+03
A3 Manufacturing	8.07E+02	3.20E-05	2.90E-01	3.44E+00	4.60E-01	8.80E-03	1.57E+04
A4 Transport to the building site	2.02E+02	4.00E-05	3.20E-02	5.60E-01	7.80E-02	1.30E-03	3.28E+03
A5 Installation into the building	3.13E+02	2.00E-06	8.90E-03	2.60E-01	6.60E-02	1.10E-04	4.39E+02
B4 Replacement	3.05E+02	1.60E-05	1.20E-01	1.43E+00	3.00E-01	2.80E-03	4.20E+03
B6 Operational energy use	5.14E+04	2.80E-04	1.00E+01	2.58E+02	1.94E+01	1.70E-02	6.46E+05
C1 Deconstruction	1.67E+01	9.20E-08	3.30E-03	8.40E-02	6.30E-03	5.50E-06	2.09E+02
C2 Waste transportation	1.07E+02	2.10E-05	1.70E-02	2.90E-01	3.80E-02	6.70E-04	1.75E+03
C3 Waste processing	3.42E+02	1.30E-05	6.10E-02	1.50E+00	5.60E-01	3.10E-02	2.34E+03
C4 Waste Disposal	9.22E+00	1.20E-06	5.20E-03	4.70E-02	6.30E-03	2.30E-05	1.68E+02
D Net benefits	-2.90E+03	-1.20E-04	-2.30E+00	-1.80E+01	-5.40E+00	-6.20E-02	-3.60E+04

Table 5. Potential environmental impacts per tkm of KONE N MonoSpace® elevator

	GWP [kg CO ₂]	ODP [kg CFC-11e]	POCP [kg C ₂ H ₄]	AP [kg SO ₂]	EP [kg PO ₄]	ADP-elements [kg Sbe]	ADP-fossil [MJ]
A1 Materials Manufacturing	2.19E+01	1.52E-06	9.65E-03	1.44E-01	5.38E-02	3.01E-03	3.06E+02
A2 Transport to the manufacturer	1.18E-01	2.21E-08	1.80E-05	3.04E-04	3.87E-05	1.16E-06	1.83E+00
A3 Manufacturing	1.11E+00	4.42E-08	4.01E-04	4.75E-03	6.35E-04	1.22E-05	2.17E+01
A4 Transport to the building site	2.79E-01	5.52E-08	4.42E-05	7.73E-04	1.08E-04	1.80E-06	4.53E+00
A5 Installation into the building	4.33E-01	2.76E-09	1.23E-05	3.59E-04	9.12E-05	1.52E-07	6.06E-01
B4 Replacement	4.21E-01	2.21E-08	1.66E-04	1.98E-03	4.14E-04	3.87E-06	5.80E+00
B6 Operational energy use	7.10E+01	3.87E-07	1.39E-02	3.57E-01	2.68E-02	2.35E-05	8.92E+02
C1 Deconstruction	2.30E-02	1.27E-10	4.56E-06	1.16E-04	8.70E-06	7.60E-09	2.89E-01
C2 Waste transportation	1.48E-01	2.90E-08	2.35E-05	4.01E-04	5.25E-05	9.25E-07	2.42E+00
C3 Waste processing	4.73E-01	1.80E-08	8.43E-05	2.07E-03	7.73E-04	4.28E-05	3.23E+00
C4 Waste Disposal	1.27E-02	1.66E-09	7.18E-06	6.49E-05	8.70E-06	3.18E-08	2.31E-01
D Net benefits	-4.01E+00	-1.66E-07	-3.18E-03	-2.49E-02	-7.46E-03	-8.56E-05	-4.97E+01

Table 6. The use of resources per entire life cycle of KONE N MonoSpace® elevator

	Use of renewable primary energy resources as energy [MJ]	Use of renewable primary energy resources as raw materials [MJ]	Total use of renewable primary energy [MJ]	Use of non renewable primary energy as energy [MJ]	Use of non renewable primary energy as raw materials [MJ]	Total use of non renewable primary energy [MJ]	Use of secondary materials [kg]*	Use of renewable secondary fuels [MJ]	Use of non renewable secondary fuels [MJ]	Use of net fresh water [m3]
A1 Materials Manufacturing	5.51E+02	1.96E+04	2.02E+04	7.80E+03	2.32E+05	2.40E+05	1.35E+03	0.00E+00	4.53E+03	1.56E+02
A2 Transport to the manufacturer	1.85E+01	0.00E+00	1.85E+01	1.35E+03	0.00E+00	1.35E+03	0.00E+00	0.00E+00	2.67E+00	2.60E-01
A3 Manufacturing	4.30E-01	1.09E+04	1.09E+04	1.11E+01	1.65E+04	1.65E+04	0.00E+00	0.00E+00	6.75E+01	1.31E+01
A4 Transport to the building site	4.78E+01	0.00E+00	4.78E+01	3.34E+03	0.00E+00	3.34E+03	0.00E+00	0.00E+00	5.19E+00	6.80E-01
A5 Installation into the building	2.04E+01	2.62E+00	2.30E+01	4.26E+02	2.34E+01	4.50E+02	0.00E+00	0.00E+00	1.99E+00	3.30E-01
B4 Replacement	6.79E+01	8.13E+02	8.80E+02	1.07E+03	3.31E+03	4.38E+03	4.19E+01	0.00E+00	1.17E+02	3.76E+00
B6 Operational energy use	4.67E+04	0.00E+00	4.67E+04	6.61E+05	0.00E+00	6.61E+05	0.00E+00	0.00E+00	1.43E+02	7.79E+01
C1 Deconstruction	1.51E+01	0.00E+00	1.51E+01	2.14E+02	0.00E+00	2.14E+02	0.00E+00	0.00E+00	4.60E-02	2.50E-02
C2 Waste transportation	2.56E+01	0.00E+00	2.56E+01	1.79E+03	0.00E+00	1.79E+03	0.00E+00	0.00E+00	2.78E+00	3.60E-01
C3 Waste processing	1.16E+00	2.35E+02	2.36E+02	3.61E+01	2.42E+03	2.46E+03	0.00E+00	0.00E+00	4.81E+00	1.54E+00
C4 Waste Disposal	0.00E+00	2.62E+01	2.62E+01	0.00E+00	1.72E+02	1.72E+02	0.00E+00	0.00E+00	5.55E+00	1.30E-01
D Net benefits	-3.80E-01	-2.40E+03	-2.40E+03	-1.50E+01	-3.60E+04	-3.60E+04	0.00E+00	0.00E+00	-3.10E+03	-1.10E+01

Table 7. The use of resources per tkm of KONE N MonoSpace® elevator

	Use of renewable primary energy resources as energy [MJ]	Use of renewable primary energy resources as raw materials [MJ]	Total use of renewable primary energy [MJ]	Use of non renewable primary energy as energy [MJ]	Use of non renewable primary energy as raw materials [MJ]	Total use of non renewable primary energy [MJ]	Use of secondary materials [kg]*	Use of renewable secondary fuels [MJ]	Use of non renewable secondary fuels [MJ]	Use of net fresh water [m3]
A1 Materials Manufacturing	7.61E-01	2.71E+01	2.79E+01	1.08E+01	3.20E+02	3.31E+02	1.87E+00	0.00E+00	6.26E+00	2.15E-01
A2 Transport to the manufacturer	2.55E-02	0.00E+00	2.55E-02	1.86E+00	0.00E+00	1.86E+00	0.00E+00	0.00E+00	3.69E-03	3.59E-04
A3 Manufacturing	5.94E-04	1.51E+01	1.51E+01	1.54E-02	2.28E+01	2.28E+01	0.00E+00	0.00E+00	9.32E-02	1.80E-02
A4 Transport to the building site	6.60E-02	0.00E+00	6.60E-02	4.61E+00	0.00E+00	4.61E+00	0.00E+00	0.00E+00	7.17E-03	9.39E-04
A5 Installation into the building	2.82E-02	3.62E-03	3.18E-02	5.89E-01	3.23E-02	6.21E-01	0.00E+00	0.00E+00	2.75E-03	4.56E-04
B4 Replacement	9.37E-02	1.12E+00	1.22E+00	1.48E+00	4.57E+00	6.05E+00	5.79E-02	0.00E+00	1.62E-01	5.19E-03
B6 Operational energy use	6.44E+01	0.00E+00	6.44E+01	9.13E+02	0.00E+00	9.13E+02	0.00E+00	0.00E+00	1.98E-01	1.08E-01
C1 Deconstruction	2.09E-02	0.00E+00	2.09E-02	2.96E-01	0.00E+00	2.96E-01	0.00E+00	0.00E+00	6.35E-05	3.45E-05
C2 Waste transportation	3.53E-02	0.00E+00	3.53E-02	2.47E+00	0.00E+00	2.47E+00	0.00E+00	0.00E+00	3.84E-03	4.97E-04
C3 Waste processing	1.60E-03	3.24E-01	3.26E-01	4.98E-02	3.35E+00	3.40E+00	0.00E+00	0.00E+00	6.64E-03	2.13E-03
C4 Waste Disposal	0.00E+00	3.61E-02	3.61E-02	0.00E+00	2.37E-01	2.37E-01	0.00E+00	0.00E+00	7.67E-03	1.80E-04
D Net benefits	-5.25E-04	-3.31E+00	-3.31E+00	-2.07E-02	-4.97E+01	-4.97E+01	0.00E+00	0.00E+00	-4.28E+00	-1.52E-02

USE OF NATURAL RESOURCES

Following the requirements of EN 15804 standard, the total of renewable and non-renewable energy use is reported separately for energy used as energy carrier and energy used as raw materials. The use of resources is reported in the following tables per entire life cycle and per tkm of the elevator.

* The reported total use of secondary materials only include the amount of copper scrap and iron scrap that are used for copper production, steel production or cast iron production. Life cycle stages without the inflow of these materials were not considered for the secondary material uses.

END OF LIFE - WASTE

In addition to the waste reported by the manufacturing units during the production process (specific data), the data on the amount of waste disposed reported in the table 8 and table 9 below also includes the average data of the output flows from the Ecoinvent database for all the life cycle stages. The amount of specific waste generated including the material losses during the production of elevator modules and packaging was collected from the module manufacturing units.

Table 8. Amount of waste disposed per entire life cycle of KONE N MonoSpace® elevator

	Hazardous waste disposed [kg]	Non hazardous waste disposed [kg]	Radioactive waste disposed [kg]
A1 Materials Manufacturing	5.19E+01	1.51E+03	4.70E-01
A2 Transport to the manufacturer	3.60E-02	7.85E+01	9.00E-03
A3 Manufacturing	1.66E+00	5.31E+01	1.50E-02
A4 Transport to the building site	8.70E-02	2.82E+02	2.30E-02
A5 Installation into the building	4.90E-03	1.38E+01	6.20E-04
B4 Replacement	2.32E+00	7.19E+01	7.50E-03
B6 Operational energy use	1.46E+00	7.76E+02	2.40E-01
C1 Deconstruction	4.70E-04	2.50E-01	7.70E-05
C2 Waste transportation	4.70E-02	1.51E+02	1.20E-02
C3 Waste processing	3.50E-01	4.94E+01	7.70E-03
C4 Waste Disposal	2.94E+01	4.94E+02	6.20E-04
D Net benefits	-5.90E-01	-2.40E+02	-2.60E-02

Table 9. Amount of waste disposed per tkm of KONE N MonoSpace® elevator

	Hazardous waste disposed [kg]	Non hazardous waste disposed [kg]	Radioactive waste disposed [kg]
A1 Materials Manufacturing	7.17E-02	2.09E+00	6.49E-04
A2 Transport to the manufacturer	4.97E-05	1.08E-01	1.24E-05
A3 Manufacturing	2.29E-03	7.34E-02	2.07E-05
A4 Transport to the building site	1.20E-04	3.90E-01	3.18E-05
A5 Installation into the building	6.77E-06	1.90E-02	8.56E-07
B4 Replacement	3.20E-03	9.93E-02	1.04E-05
B6 Operational energy use	2.02E-03	1.07E+00	3.31E-04
C1 Deconstruction	6.49E-07	3.45E-04	1.06E-07
C2 Waste transportation	6.49E-05	2.09E-01	1.66E-05
C3 Waste processing	4.83E-04	6.83E-02	1.06E-05
C4 Waste Disposal	4.05E-02	6.82E-01	8.56E-07
D Net benefits	-8.15E-04	-3.31E-01	-3.59E-05





END OF LIFE - OUTPUT FLOW

The data for the output flows of the process is presented in table 10 and table 11 for the entire life cycle and per tkm respectively. The parameters in the tables are calculated on the gross amounts leaving the system boundary when they have reached the end-of-waste state. None of the components are reused after the end of the waste state, possible exported energy is not reported in the LCI datasets of Ecoinvent and there is no amount of exported energy from the manufacturing units.

Table 10. Amount of materials leaving the system boundary per entire life cycle of KONE N MonoSpace® elevator

	Components for re-use [kg]	Materials for recycling [kg]	Materials for energy recovery [kg]	Exported Energy [MJ]
A1 Materials Manufacturing	0.00E+00	1.01E+00	2.60E-08	0.00E+00
A2 Transport to the manufacturer	0.00E+00	7.50E-04	3.20E-11	0.00E+00
A3 Manufacturing	0.00E+00	4.65E+01	5.61E+00	0.00E+00
A4 Transport to the building site	0.00E+00	1.70E-03	6.30E-11	0.00E+00
A5 Installation into the building	0.00E+00	5.40E+01	1.06E+03	0.00E+00
B4 Replacement	0.00E+00	9.10E+01	3.24E+01	0.00E+00
B6 Operational energy use	0.00E+00	2.80E-01	3.60E-09	0.00E+00
C1 Deconstruction	0.00E+00	9.00E-05	1.20E-12	0.00E+00
C2 Waste transportation	0.00E+00	9.30E-04	3.40E-11	0.00E+00
C3 Waste processing	0.00E+00	4.35E+03	8.56E+01	0.00E+00
C4 Waste Disposal	0.00E+00	1.80E-04	4.10E-11	0.00E+00
D Net benefits	0.00E+00	-5.70E-03	-4.40E-10	0.00E+00

Table 11. Amount of materials leaving the system boundary per tkm of KONE N MonoSpace® elevator

	Components for re-use [kg]	Materials for recycling [kg]	Materials for energy recovery [kg]	Exported Energy [MJ]
A1 Materials Manufacturing	0.00E+00	1.40E-03	3.59E-11	0.00E+00
A2 Transport to the manufacturer	0.00E+00	1.04E-06	4.42E-14	0.00E+00
A3 Manufacturing	0.00E+00	6.4E-02	7.74E-03	0.00E+00
A4 Transport to the building site	0.00E+00	2.35E-06	8.70E-14	0.00E+00
A5 Installation into the building	0.00E+00	7.45E-02	1.47E+00	0.00E+00
B4 Replacement	0.00E+00	1.25E-01	4.47E-02	0.00E+00
B6 Operational energy use	0.00E+00	3.87E-04	4.97E-12	0.00E+00
C1 Deconstruction	0.00E+00	1.24E-07	1.66E-15	0.00E+00
C2 Waste transportation	0.00E+00	1.28E-06	4.70E-14	0.00E+00
C3 Waste processing	0.00E+00	6.01E+00	1.18E-01	0.00E+00
C4 Waste Disposal	0.00E+00	2.49E-07	5.66E-14	0.00E+00
D Net benefits	0.00E+00	-7.87E-06	-6.08E-13	0.00E+00

SCENARIOS AND ADDITIONAL TECHNICAL INFORMATION



ELECTRICITY IN THE MANUFACTURING PHASE

Electricity production is based on the Ecoinvent data source of version 3.4. Since all the elevator components are manufactured in China, the impacts of electricity for the manufacturing units have been calculated using the energy production fuel mixes provided for China by Ecoinvent where the basic source used is China Electric Power Yearbook 2015. The data includes the used fuel mixes, imported energy as well as production output and, transmission and distribution losses. The impacts of the electricity mix are calculated using the obtained fuel mixes and the impacts of the different fuels and using the output of energy as denominator thus resulting in impacts per kWh of energy. The resulting impact factor used in the calculation are presented in the table below. No amount of district heating was reported by any of the manufacturing units.

Electricity in the manufacturing stage

A1 data quality of electricity and CO ₂ emissions, kg CO ₂ emissions equivalent/kWh	CN 1.1	Based on country specific fuel mixes for the production year 2014 from China Electric Power Yearbook 2015.
		Imported electricity has been considered. The environmental impacts include all upstream processes as well as transmission losses.

INSTALLATION OF THE STUDIED PRODUCT IN THE BUILDING

Parameter	Unit
Ancillary materials used for installation	glues and disposable gloves(not included in the analysis because of their insignificant usage amount)
Water use	0 m3
Energy consumption	15 kWh
Waste materials generated by product installation	
Wood	820.68 kg
Steel	54.00 kg
Plastic	114.06 kg
Cardboard	63.02 kg

REPLACEMENT

Parameter	Unit
Replacement cycle	2 per reference service life
Energy input	0 kWh
Materials	
Steel	97.72 kg
hemp fiber	6.768 kg
lubricating oil	2.4 kg

TRANSPORT FROM PRODUCTION PLACE TO USER

Variable	Amount	Data quality
Fuel type and consumption in liters / 100 km	50	Truck > 32 tons, EURO 5 classification, diesel
Transportation distance km	2366	Total road transportation used for transporting the elevator modules from their respective manufacturing units to DC and then to building site.
Transport capacity utilization %	100	Truck is fully loaded while delivering the product to the building
Bulk density of transported products kg/m ³	N.A.	
Volume capacity utilisation factor (factor: =1 or <1 or ≥ 1 for compressed or nested packaged products)	1	Assumption

END-OF-LIFE PROCESS DESCRIPTION

The N MonoSpace® is mainly composed of ferrous metals and concrete. A realistic assumption is made that whole of the elevator and its parts are collected separately during the dismantling process. 10% of the elevator's material is assumed to be not recyclable with current technologies. Ferrous metals, non-ferrous metals as well as electronic components used in the elevator can all be recycled after the end of life. Batteries and lubricating oils used in the elevator are treated as hazardous waste and incineration is considered for small proportion of combustible materials (mainly plastics).

Processes	Unit (expressed per functional unit or per declared unit of components products or materials and by type of material)	Amount kg/kg Data quality
Collection process specified by type	kg collected separately	1
	kg collected with mixed construction waste	0
Recovery system specified by type	kg for re-use	0
	kg for recycling	0.88*
	kg for energy recovery	0.02*
Disposal specified by type	kg product or material for final deposition	0.10*
Assumptions for scenario development, e.g. transportation	units as appropriate	Transportation distance for end of life treatment scenarios assumed to be 250 km

* Values are calculated based on the most common treatment scenarios currently in use for the materials.



RECOGNITIONS:

CLIMATE LEADERSHIP

KONE has maintained a CDP Climate Leadership score (A or A-) for seven years running as the only elevator company and achieved A score for Supplier Engagement for the third year running in 2020.



ONE OF THE MOST SUSTAINABLE COMPANIES IN THE WORLD

KONE ranked 32nd on the 2020 Corporate Knights Global 100 list of most sustainable corporations in the world as the only elevator and escalator company.

RECOGNITION FOR INNOVATIVE OFFERING

KONE was ranked as one of the world's most innovative companies by the business magazine Forbes in 2018. KONE ranked 59th and was the only elevator and escalator company on the list.

A-CLASS ENERGY RATING

KONE N MonoSpace® has received the best possible A-class energy rating according to the international ISO 25745-2 energy efficiency standard for elevators.



GLOSSARY

ADP, Abiotic depletion potential, expressed in kg Antimony (Sb) equivalent. for non-fossil resources and in MJ for fossil resources. In the CML method the non-fossil resources include e.g. silver, gold, copper, lead, zinc and aluminium.

AP, acidification potential, expressed in kg sulphuric dioxide (SO₂) equivalent. The indicator expresses acidification potential which originates from the emissions of sulphur dioxide and oxides of nitrogen. In the atmosphere, these oxides react and form acids which subsequently fall down to the earth in the form of rain or snow, or as dry depositions. Inorganic substances such as sulphates, nitrates, and phosphates change soil acidity. Major acidifying substances are nitrogen oxides (NO_x), ammonia (NH₃) and sulphate (SO₄).

CML, a methodology for life cycle impact assessment created by University of Leiden in the Netherlands in 2001. It is publicly available and contains more than 1700 different flows. It includes impact categories of acidification, climate change, depletion of abiotic resources, ecotoxicity, eutrophication, human toxicity, ozone layer depletion and photochemical oxidation.

EPD, environmental product declaration, provides numeric information about product's environmental performance and facilitates comparison between different products with the same function. EPDs for KONE are based on life cycle assessment.

EP, eutrophication potential, expressed in kg phosphate (PO₄₃-) equivalent. Eutrophication describes emissions of substances to water that contribute to oxygen depletion. It means nutrient enrichment of an aquatic environment. Biomass growth in aquatic ecosystems may be limited by various nutrients. Most of the time, aquatic ecosystems are saturated with either nitrogen or phosphorus, and only the limiting factor can cause eutrophication. The CML method takes into account nitrogen and phosphorus related emissions.

Functional unit, The quantified performance of a product system for use as a reference unit.

GWP, global warming potential, expressed in kg carbon dioxide (CO₂) equivalent. The indicator expresses global

warming potential and refers to carbon footprint. It considers gaseous substances such as carbon dioxide (CO₂), methane (CH₄), laughing gas (N₂O) over 100 years. These substances have an ability to absorb infrared radiation in the earth's atmosphere. They let sunlight reach the earth's surface and trap some of the infrared radiation emitted back into space causing an increase in the earth's surface temperature.

LCA, life cycle assessment, is a method which quantifies the total environment impact of products or activities over their entire life cycle and life cycle thinking. Life cycle assessment is based on ISO 14040 and ISO 14044 standards and comprises four phases: goal and scope definition, inventory data collection and analysis, environmental impact assessment and interpretation of results. The results of LCA are used in communication and product development purposes, for example.

ODP, Ozone depletion potential, expressed in kg trichlorofluoromethane (CFC-11) equivalent. Ozone-depleting gases cause damage to stratospheric ozone or the "ozone layer". Chlorofluorocarbons (CFCs), halons and hydrochlorofluorocarbon (HCFCs) are the potent destroyer of ozone, which protects life on earth from harmful UV radiation. Damage to the ozone layer reduces its ability to prevent ultraviolet (UV) light entering the earth's atmosphere, increasing the amount of carcinogenic UVB light reaching the earth's surface. The CML impact calculation method takes into account all different forms of CFC, HCFC and halons related emissions.

Product Category rules (PCR) define the rules and requirements for EPDs of a certain product category. They are a key part of ISO 14025 as they enable transparency and comparability between EPDs

POCP, photochemical ozone creation potential, expressed in kg ethylene C₂H₄ equivalent. Photochemical ozone or ground level ozone is formed by the reaction of volatile organic compounds and nitrogen oxides in the presence of heat and sunlight. Ground-level ozone forms readily in the atmosphere, usually during hot summer weather. Photochemical oxidant formation is harmful to both humans and plants. The CML method takes into account certain emissions to air, for example, carbon monoxide (CO), ethyne (C₂H₂) and formaldehyde (CH₂O).

ADDITIONAL TECHNICAL INFORMATION

www.kone.com

Contact your local KONE sales organization to learn more about the technical details of the products available in your region.

ADDITIONAL INFORMATION

All the impacts specified by EN 15804 have been studied for all the information modules.

The EPD is compiled with KONE-EPD One-Click LCA tool which is certified by RTS.

Tool Declaration number: RTS_EPД_TOOL_1_19
Tool Registration number: RTS_EPД_TOOL_1_19
Tool issue date: 14.11.2019
Tool valid until: 28.10.2022

BIBLIOGRAPHY

ISO 14025:2010 Environmental labels and declarations – Type III environmental declarations Principles and procedures.

ISO 14040:2006 Environmental management. Life cycle assessment. Principles and frameworks.

ISO 14044:2006 Environmental management. Life cycle assessment. Requirements and guidelines.

EN 15804:2012+A1 Sustainability in construction works – Environmental product declarations – Core rules for the product category of construction products.

RTS PCR 14.6.2018 RTS PCR protocol: EPDs published by the Building Information Foundation RTS sr. PT 18 RT EPD Committee. (English version)

EN-ISO 25745-2 Energy performance of lifts, escalators and moving walks - Part 2: Energy calculation and classification for lifts (elevators)

Ecoinvent database v3.4

Functional unit calculation and product specifications method adopted from PCR 2015 Product category Rules according to ISO 14025. Lifts (Elevators) Product classification: UN CPC 4354. Version 1.0.

KONE provides innovative and eco-efficient solutions for elevators, escalators, automatic building doors and the systems that integrate them with today's intelligent buildings.

We support our customers every step of the way; from design, manufacturing and installation to maintenance and modernization. KONE is a global leader in helping our customers manage the smooth flow of people and goods throughout their buildings.

Our commitment to customers is present in all KONE solutions. This makes us a reliable partner throughout the life cycle of the building. We challenge the conventional wisdom of the industry. We are fast, flexible, and we have a well-deserved reputation as a technology leader, with such innovations as KONE MonoSpace® DX, KONE NanoSpace™ and KONE UltraRope®.

KONE employs close to 57,000 dedicated experts to serve you globally and locally.

KONE CORPORATION

Corporate offices

Keilasatama 3
P.O. Box 7
FI-02151 Espoo
Finland
Tel. +358 (0)204 751

www.kone.com

This publication is for general informational purposes only and we reserve the right at any time to alter the product design and specifications. No statement in this publication shall be construed as a warranty or condition, express or implied, as to any product, its fitness for any particular purpose, merchantability, quality or representation of the terms of any purchase agreement. Minor differences between printed and actual colors may exist. KONE MonoSpace® DX, KONE EcoDisc®, KONE Care® and People Flow® are registered trademarks of KONE Corporation. Copyright © 2020 KONE Corporation.